









Anti-glare RGB+CCT LED Downlight

Model No.: FUT070 / FUT071

Features

-  Deepen the cover
Prevent glare effectively
-  RGB+CCT
16 Millions of colors to choose
-  Color temperature
2700~6500K
-  Dimmable
Saturation control
-  2.4G RF wireless transmission
technology
-  Signal transmitting &
Modes synchronization
-  Remote control
Control distance 30m
-  Smart phone APP control
(2.4GHz gateway is needed)
-  Support third party voice control
(2.4GHz gateway is needed)

6W Anti-glare RGB+CCT LED Downlight

Model No.: FUT070
Input Voltage: AC100~240V 50/60Hz
Power: 6W
Working Temp.: -20~60°C
CRI: >80 PF: >0.5
Color Temperature: 2700K~6500K
Luminous Flux: 550LM
Lifespan: 50000 hours
Beam Angle: 60°
RF: 2.4GHz
Control Distance: 30m

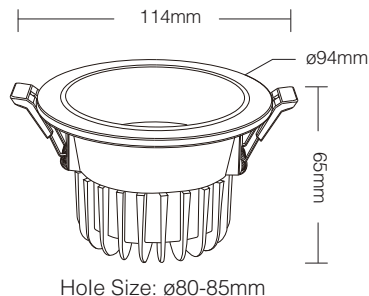

12W Anti-glare RGB+CCT LED Downlight

Model No.: FUT071
Input Voltage: AC100~240V 50/60Hz
Power: 12W
Working Temp.: -20~60°C
CRI: >80 PF: >0.5
Color Temperature: 2700K~6500K
Luminous Flux: 1000LM
Lifespan: 50000 hours
Beam Angle: 60°
RF: 2.4GHz
Control Distance: 30m

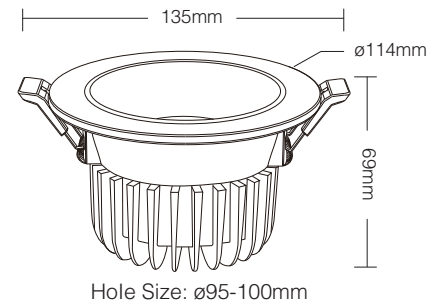

Instructions

1. Please open the hole on the ceiling according to the correct size of Diagram 1.
2. Connect the driver properly according to the wire connection Diagram 2. And then put the driver and wire into the ceiling from the hole.
3. Push in the two spring elements, make sure that they are deployed and anchored on the back of the ceiling Diagram 3 and 4.

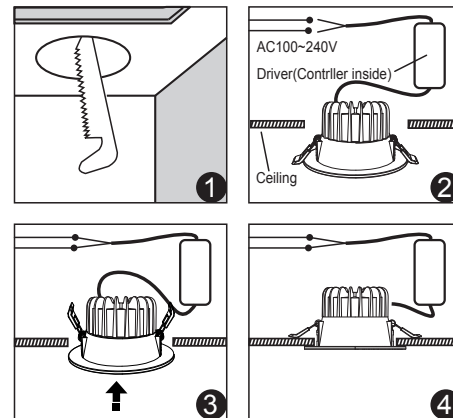

Link / Unlink

Compatible with these remote controls
(Purchased separately)

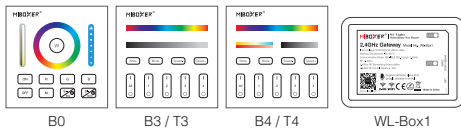
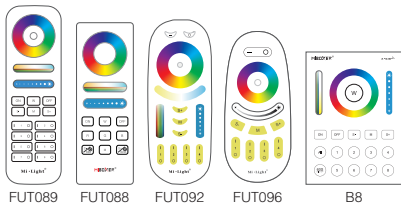

NOTE:

Lighting can be working after linking with remote;
for more details, pls read the remote instruction.

Dynamic Mode Sheet

Number	Dynamic Mode	Brightness / Saturation / Speed
1	Mardi Gras	Adjustable
2	Automatic color change	
3	Sam	
4	Gemstone	
5	Twilight	
6	American	
7	Fat Tuesday	
8	Party	
9	Slow Color Splash	

Signal transmitting

One Downlight can transmit the signals from the remote control to another Downlight within 30m, as long as there is a Downlight within 30m, the remote control distance can be limitless.

Modes synchronization

Different Downlight can work synchronously when they are started at different times, controlled by the same remote, under same dynamic mode and within 30m distance.

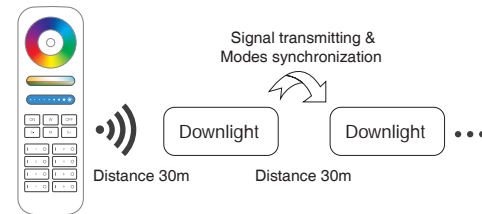

Attention

1. When install the lighting fixtures, pls switch off the power to make sure the safty.
2. Please check whether the input voltage supply is in accordance with the lighting fixtures.
3. Non-professional user cannot dismantle the lighting fixtures directly, otherwise, it may cause fire and electric shock.
4. Please do not use lighting fixtures around the mental area and high magnetic field, otherwise, it will badly affect the control distance.



Made in China