

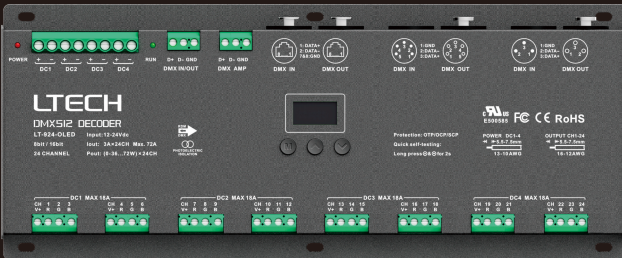

OLED display
8 bit / 16 bit
4 kinds of DMX interfaces
Dimming Curve: 0.1-9.9
Protection: OTP/OCP/SCP



Product introduction

1. Designed for Hi-power multiple channels application, 24 channels output, and Max. 3A current per channel, up to 1728W output power.
2. Easy operation with OLED screen and touch buttons.
3. 3 kinds of mode optional: single color, color temperature and RGB.
4. 3-pin XLR, 5-pin XLR, RJ45 and green terminal DMX interface with photoelectric isolation, improve signal transmission efficiency and anti-interference ability, the green terminal also has signal amplifier function.
5. With RDM remote management protocol, the operations can be completed via the RDM master console, such as parameters browsing & setting, DMX address setting, equipment recognition, etc.
6. With firmware upgrade function.
7. With short circuit, over current and over temp. protection, as well as warning function when fault.
8. With power-on state management and fast self-testing function.
9. 16bit (65536 levels) / 8bit (256 levels) grey level optional.
10. Optional for standard, linear, LOG or custom 0.1-9.9 dimming curve.

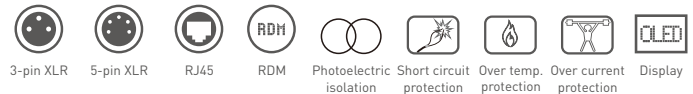
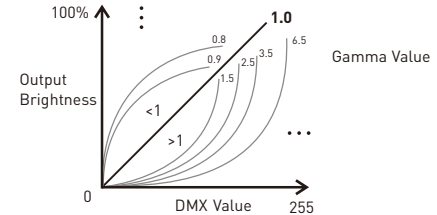

Technical specs

Model :	LT-924-OLED
Input signal :	DMX512/RDM
Input voltage :	12-24Vdc
Current load :	3A × 24CH Max 72A
Output power :	(0-36W...72W) × 24CH Max. 1728W
DMX interface :	3-pin XLR, 5-pin XLR, RJ45, Green terminal
Control mode :	Dimming/CT/RGB
Dimming curve :	0.1-9.9, standard, linear, LOG
Grey level :	8bit (256 levels) / 16bit (65536 levels)
Photoelectric isolation :	Yes
Protection:	Short circuit / Over current / Over temperature
Working temperature :	-30°C-65°C
Dimensions :	L300×W122×H39mm
Package size :	L313×W127×H41mm
Weight (G.W.) :	1180g



Product size

Unit: mm

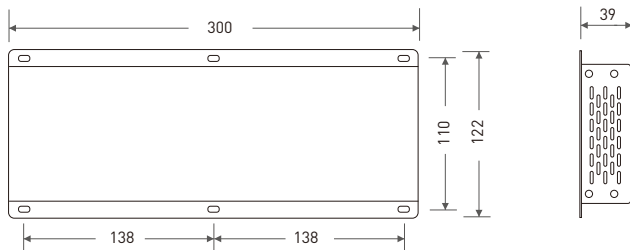

2

Main component description

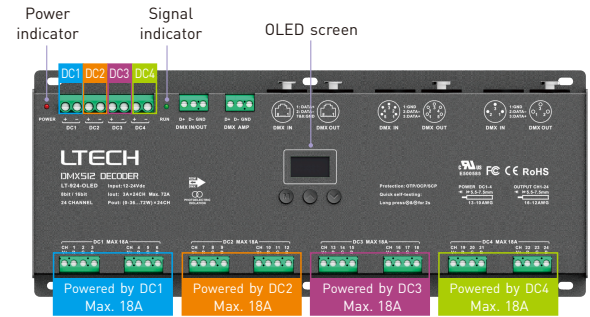

DMX/RDM input & output

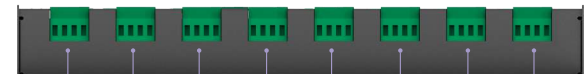

Green terminals
LED lamps connection

3

OLED screen interface



Press "M" key, switch entries.
 Long press "M" key, back to main page.
 Press "^" or "v" key, parameter adjustment.
 Exit: back to previous page.

1. DMX address setting

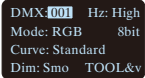

Main page

Press "^" or "v" key to set DMX address.
 Range: 001-512

2. PWM frequency

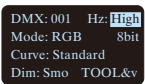

Press "^" or "v" key to choose. **No flicker in video camera.**
 Optional : Std (standard) High (middle) Low

Smooth and exquisite, human eye is comfortable. * It is recommended to use standard.

3. Mode

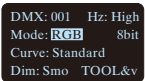

Press "^" or "v" key to choose.
 Optional : Dim CT RGB

4. Grey scale

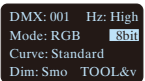

Press "^" or "v" key to choose.
 Optional : 8bit 16bit (choose it if the master controller support this function)

5. Dimming curve

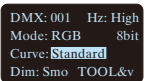

Press "^" or "v" key to choose.
 Optional : Standard Linear LOG 0.1-9.9
 It is recommended to use standard, 0.1-9.9 is for special requirements.

6. Enhance dimming

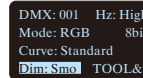

Press "^" or "v" key to choose.

Optional : Std (standard) Smo (smooth)

* It is recommended to use standard.

Smo: This option with smooth processing, realize the dimming flicker-free and dynamic effects more downy.

7. Tool

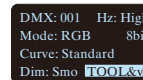

Press "^" or "v" key to enter submenu.

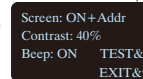

Press "^" or "v" key to enter submenu of test.



Screen: ON+Addr
 Screensaver open and display address if undo for 2 minutes.

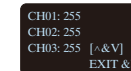

Brightness setting (range: 0-255)
 Press "^" or "v" to next page.
 Press "v" to exit.

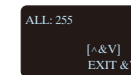

Change all value simultaneously. (on the last page)



Screen: ON+black
 Screensaver open and black if undo for 2 minutes.

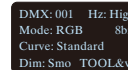

Screen: OFF
 Screensaver not enable.

* Fast self-testing function: press "^" or "v" keys simultaneously for 2-3 seconds under any page, decoder will enter self-testing function.

Wiring diagram

1. Connecting LED lights:

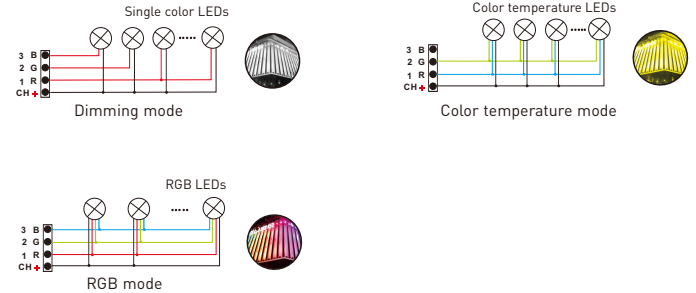
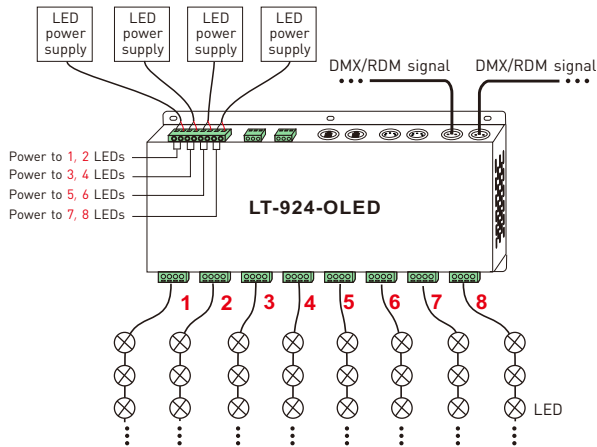
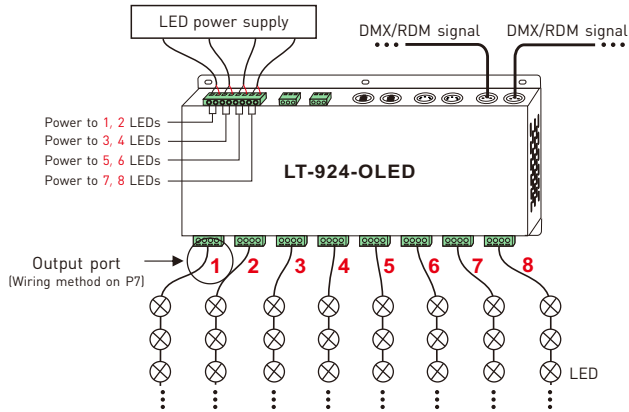

2. DMX console connection:

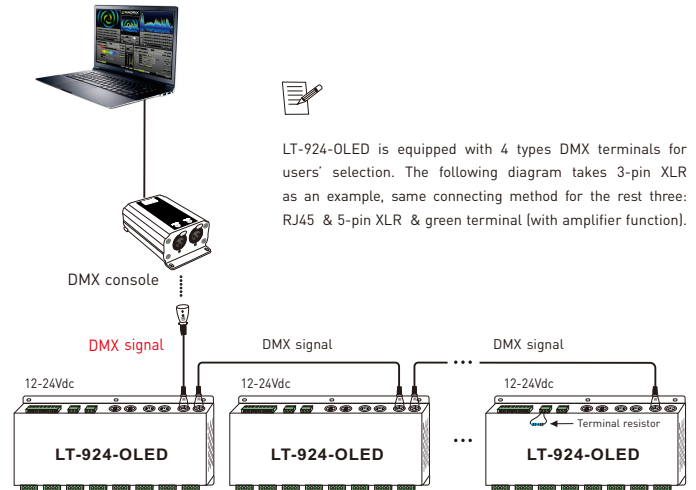

* If the recoil effect occurs because of longer signal line or bad line quality, please try to connect 0.25W 90-120Ω terminal resistor at the end of each line.

3. The connection diagram of 4 kinds of DMX/RDM terminals:

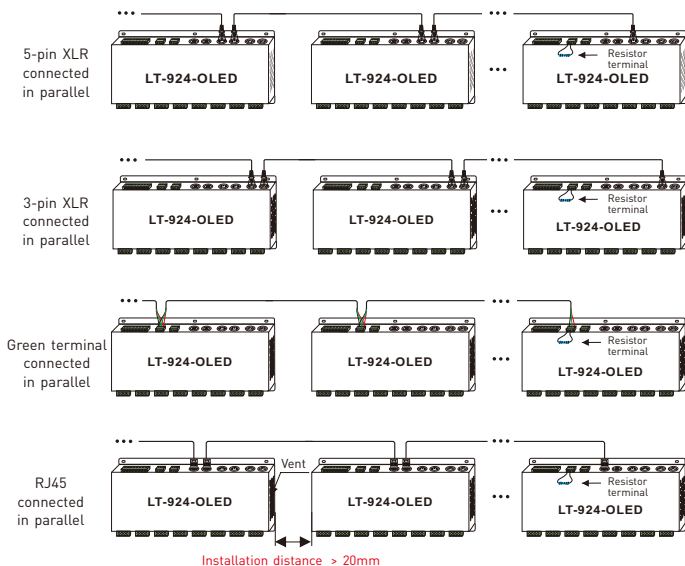

These 4 terminals can be connected in a mixed way.

*** Installation attention :** please reserve enough ventilation distance between decoders (>20mm), be sure not to block the vent, or will affect lifetime of decoder for poor heat dissipation.

4. The connection diagram of AMP signal amplifier terminal:

*** Connecting with green terminal or an extra amplifier will be needed when more than 32 decoders are connected or use overlong signal wire (as shown below). Signal amplifier should not be more than 5 times continuously.**

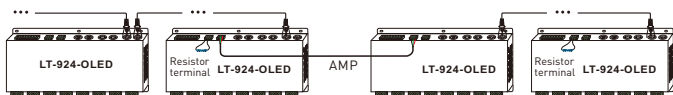

Address setting table

Mode	DIM	CT	RGB
Address quantity	8	16	24
Resolution	8bit	8bit	8bit
Channel	1	001	001 001
	2	001	002 002
	3	001	002 003
	4	002	003 004
	5	002	004 005
	6	002	004 006
	7	003	005 007
	8	003	006 008
	9	003	006 009
	10	004	007 010
	11	004	008 011
	12	004	008 012
	13	005	009 013
	14	005	010 014
	15	005	010 015
	16	006	011 016
	17	006	012 017
	18	006	012 018
	19	007	013 019
	20	007	014 020
	21	007	014 021
	22	008	015 022
	23	008	016 023
	24	008	016 024

Mode	DIM	CT	RGB
Address quantity	16	32	48
Resolution	16bit	16bit	16bit
Channel	1	001 002	001 002 001 002
	2	001 002	003 004 003 004
	3	001 002	003 004 005 006
	4	003 004	005 006 007 008
	5	003 004	007 008 009 010
	6	003 004	007 008 011 012
	7	005 006	009 010 013 014
	8	005 006	011 012 015 016
	9	005 006	011 012 017 018
	10	007 008	013 014 019 020
	11	007 008	015 016 021 022
	12	007 008	015 016 023 024
	13	009 010	017 018 025 026
	14	009 010	019 020 027 028
	15	009 010	019 020 029 030
	16	011 012	021 022 031 032
	17	011 012	023 024 033 034
	18	011 012	023 024 035 036
	19	013 014	025 026 037 038
	20	013 014	027 028 039 040
	21	013 014	027 028 041 042
	22	015 016	029 030 043 044
	23	015 016	031 032 045 046
	24	015 016	031 032 047 048

Work with RDM editor

LT-924-OLED can work with LTECH RDM editor (Model: WiFi-RDM01) to realize changing the parameters by long-range setting, wiring diagram as below:

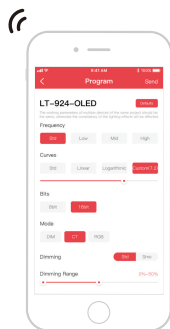
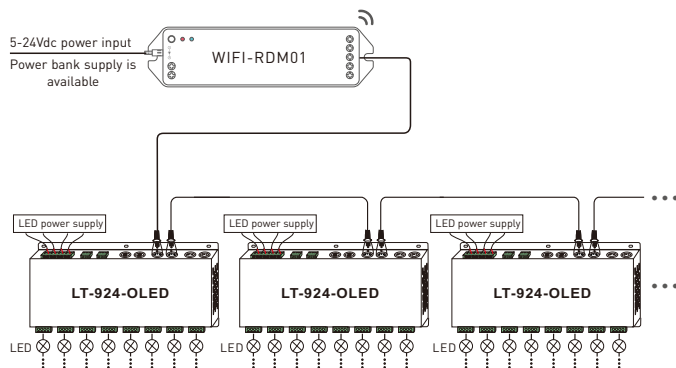

RDM editor App interface instruction

Download the App, setting the LT-924-OLED parameters (frequency, bit, curve, modes, dimming range, screensaver, etc.) after well connecting the RDM editor, more details, please check the manual of WiFi-RDM01.

Well installation of products first, then working with WiFi-RDM01 to realize setting parameters and firmware upgrade by App.

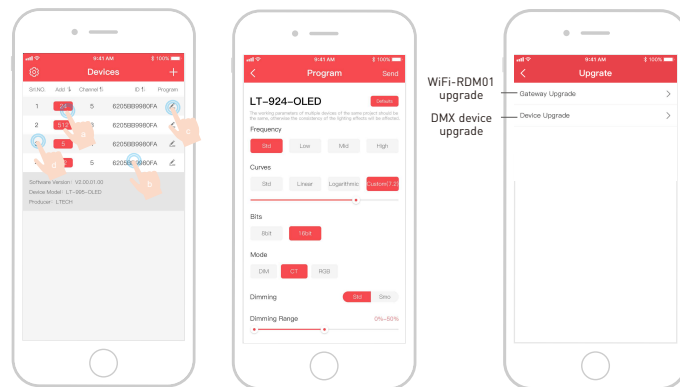

- click "Add", edited the address in corresponding box.
- Click "ID", get more product details.
- Click " ", enter edited interface
- Click "No.", issue the recognizing command.

Supporting WiFi-RDM01 upgrade and DMX driver upgrade.

* No further notice if any changes in the manual.
Product function depends on the goods.
Please feel free to contact your supplier if any question.