

T +44 (0) 1942 671122 E sales@plusopto.co.uk W www.plusopto.co.uk  
B13 Derwent Court William Way Moss Industrial Estate Leigh Lancashire WN7 3PT

## Flexible Strip Wall washer

---

Model: PF2621 series





## Product features

- Using optical grade environmental protection silicone material, salt resistance, acid and alkali corrosion resistance, flame retardant, UV resistance;
- The free bending structure design can perfectly fit the outdoor curved surface of various arcs to achieve the effect of wall washing
- Integrated extrusion molding process, waterproof grade up to Ip65;
- Patented optical structure design, a variety of angles optional;
- Hidden end cap design, easy to install;



## Product Dimension

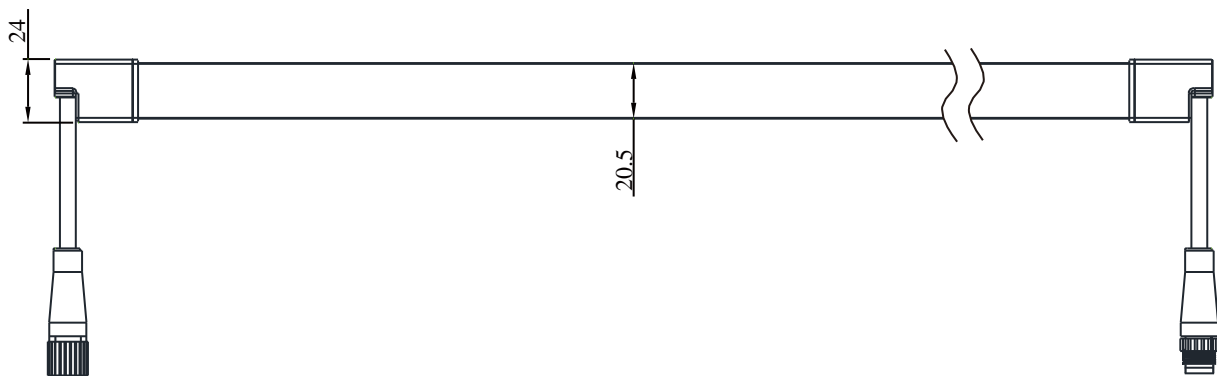
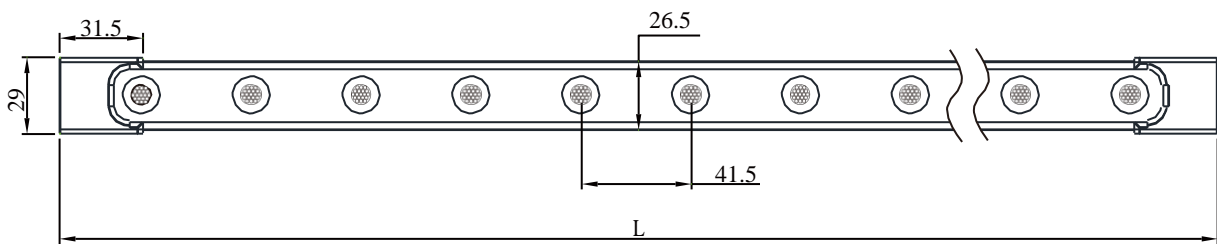

## Bending Diameter

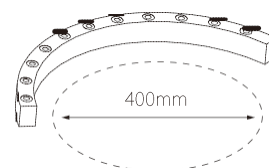
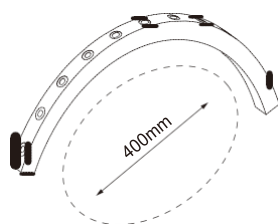

## Basic Parameters

Input Voltage	24V	Working temperature	-25°C~+40°C
CRI	>80	Cutable length	250mm
Beam angle(50%)	15°/30°/50°/20*35°/18*20°/20*55°	Waterproof level	IP65
LEDs / M	24LEDs	Max. run length	5m
Warranty period	3 years	Net weight	590g/m
Control mode	PWM		

Note: RGBW only has beam angle: 35° / 30°x45°.

## White color parameters

CCT	LEDs/m	Power(W/M)	CRI	LM/M	LM/W
2700K (2500K~2850K)	24	24	80	1525	63.5
3000K (2800K~3200K)		24	80	1580	65.8
4000K (3800K~4200K)		24	80	1545	64.4
6500K (6200K~6800K)		24	80	1480	61.7

## Tunable white parameters

CCT	LEDs/m	Power(W/M)	CRI	LM/M	LM/W
2700K only (2500K~2850K)	24	12	80	850	70.8
6500K only (6200K~6800K)		12	80	840	70.0
2700K+6500K		24	80	1600	66.7

## RGB color parameters

CCT	LEDs/m	Power(W/M)	LM/M	LM/W
Red only	24	6	150	25.0
Green only		6	260	43.3
Blue only		6	65	10.8
RGB		18	515	28.6

### RGBW parameters

CCT	LEDs/m	Power(W/M)	LM/M	LM/W
Red only	24	4.5	140	31
Green only		4.5	340	75
Blue only		4.5	64	14
White		4.5	380	84
RGBW		18	850	47

### DMX512 RGB parameters

CCT	IC Type	LEDs/m	Pixels/m	Power(W/M)	LM/M	LM/W
Red only	SM18522PH	24	4	6	145	24.2
Green only				6	360	60.0
Blue only				6	65	10.8
RGB				18	515	28.6

### DMX512 RGBW parameters

CCT	IC Type	LEDs/m	Pixels/m	Power(W/M)	LM/M	LM/W
Red only	SM18522PH	24	4	4.5	140	31.1
Green only				4.5	340	75.5
Blue only				4.5	64	14.2
W				4.5	380	34.4
RGBW				18	850	47.2

Note:

1. Test ambient temperature is 25°C(±2°C);
2. Brightness deviation is ±10%;
3. The Angle of the test sample is 30°;

# Light Distribution Curve

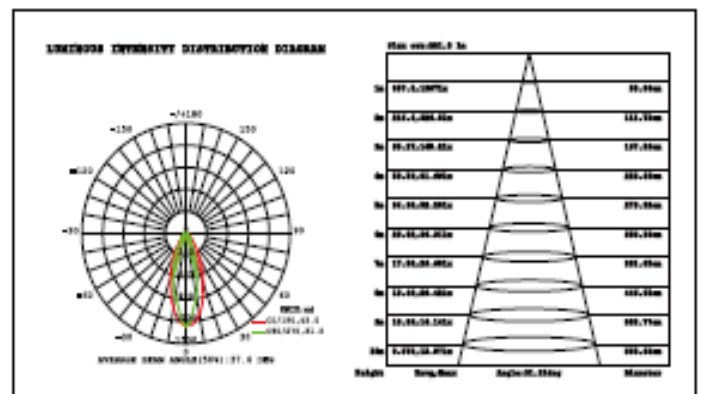
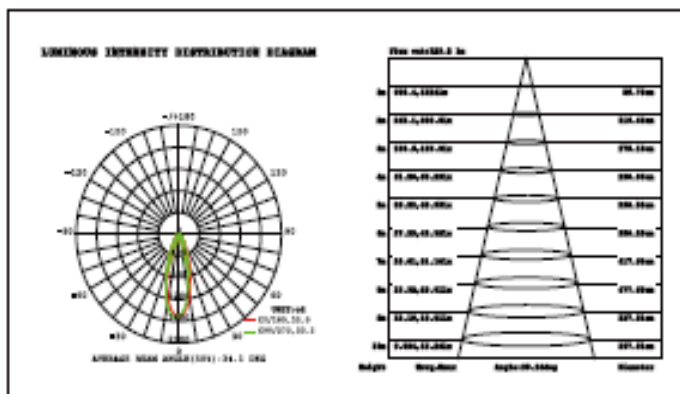
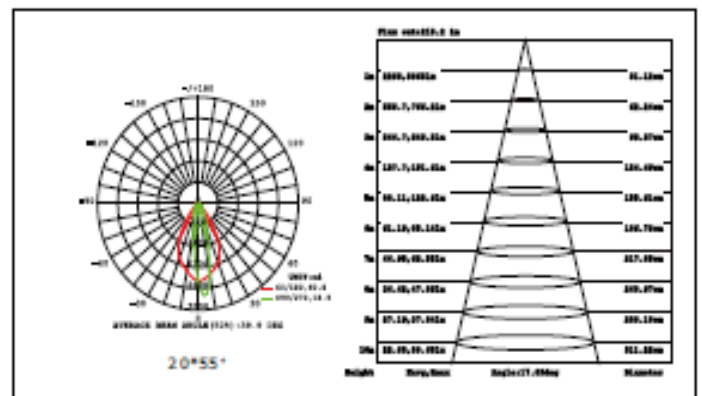
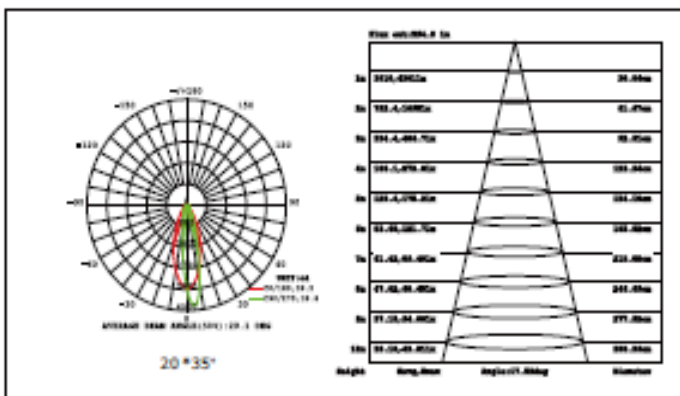
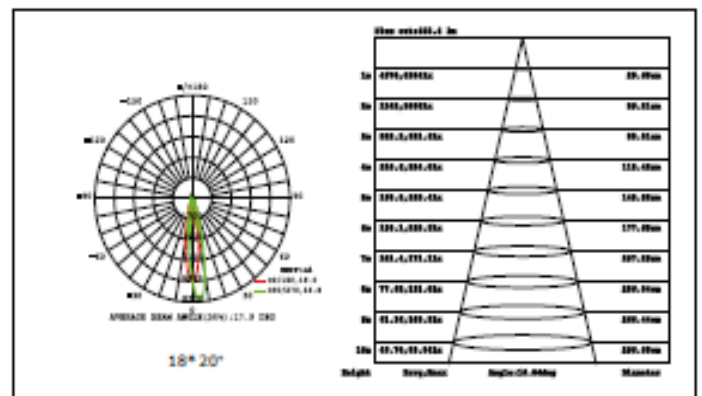
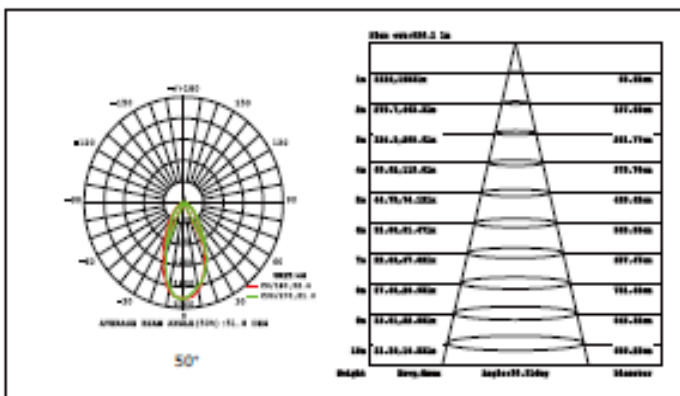
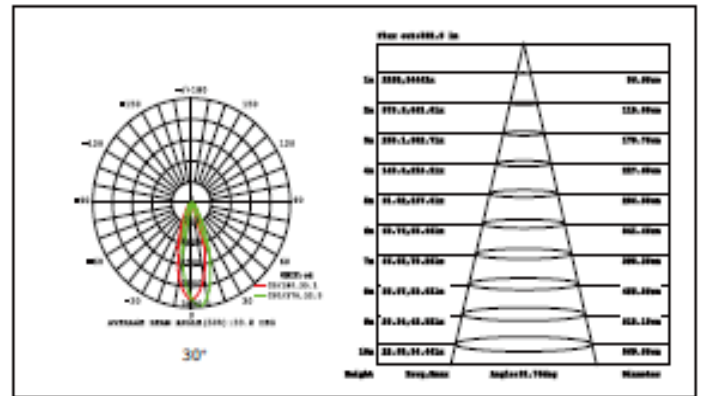
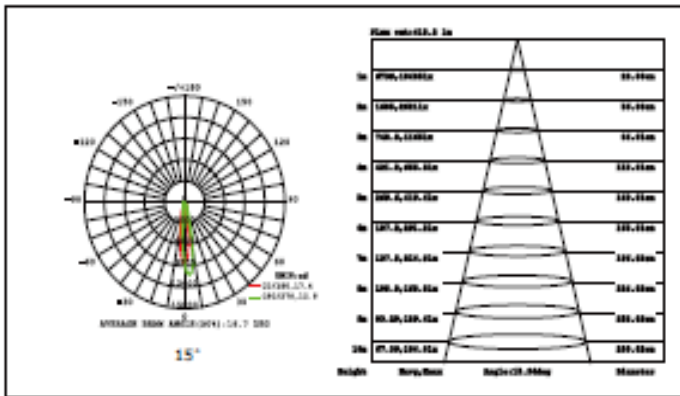

Note: Test samples is 4000K

## Aluminum Clip

---

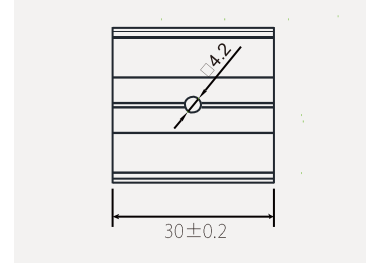
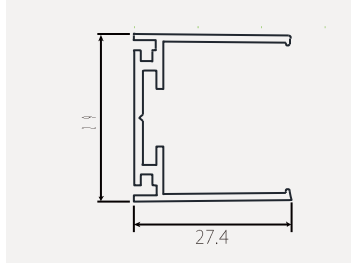

---

## Adjustable Angle Clip (use with aluminum clips or profile)

---

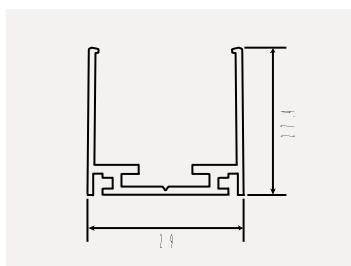
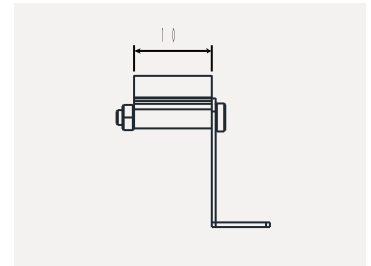
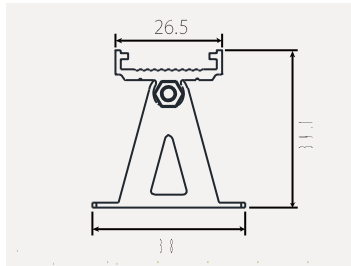

# Installation Diagram

Aluminum Clip

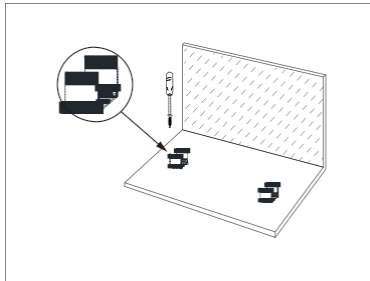

Fix the aluminum clips to the mounting surface with the screwdriver

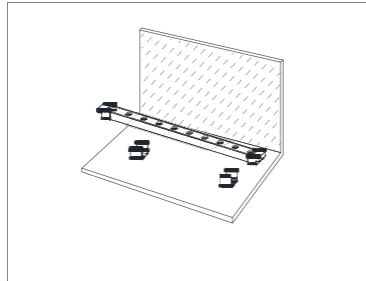

Clamp the wall washer light on the aluminum clips;

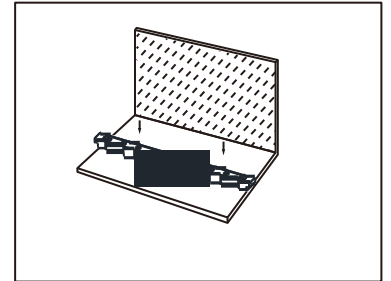

Turn on the power

Installation with Aluminum Profile

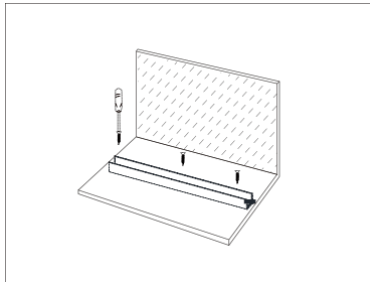

Fix the aluminum profile to the mounting surface with the screwdriver.

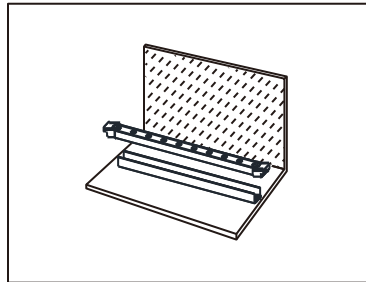

Clamp the wall washer light on the aluminum profile;

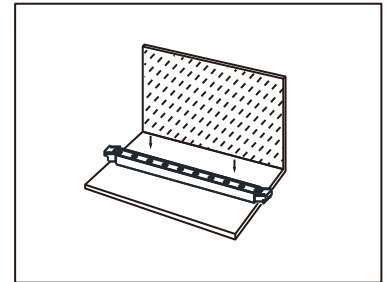

Turn on the power.

Installation with Adjustable Angle Clip  
↓  
Aluminum Clip

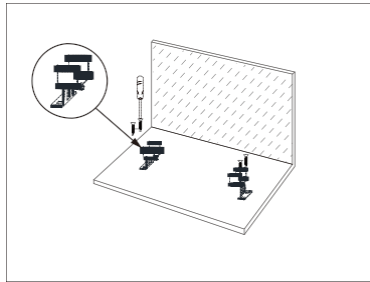

Fix the adjustable angle clips to the mounting surface with the screwdriver then fix the aluminum clips onto the adjustable angle clips.

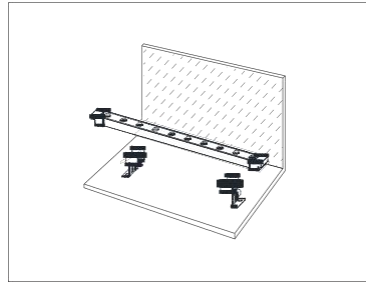

Clamp the wall washer light on the aluminum clips.

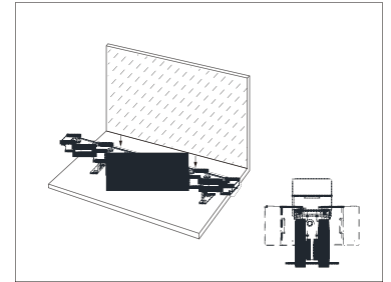

As shown in the schematic diagram in the right corner, adjust the clips to the required angle, and then turn on the power.

Installation with Adjustable Angle Clip  
↓  
Aluminum Profile

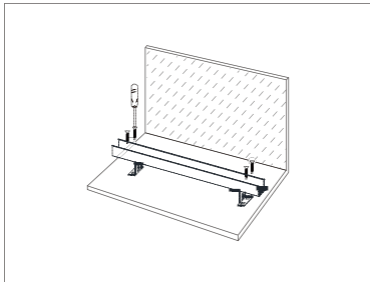

Fix the adjustable angle clips to the mounting surface with the screwdriver then fix the aluminum profile onto the adjustable angle clips.

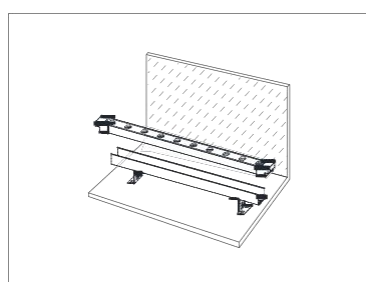

Clamp the wall washer light on the aluminum profile.

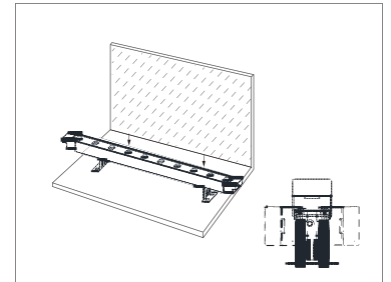

As shown in the schematic diagram in the right corner, adjust the aluminum profile to the required angle, and then turn on the power.

## Installation Distance/Wall Washing Height

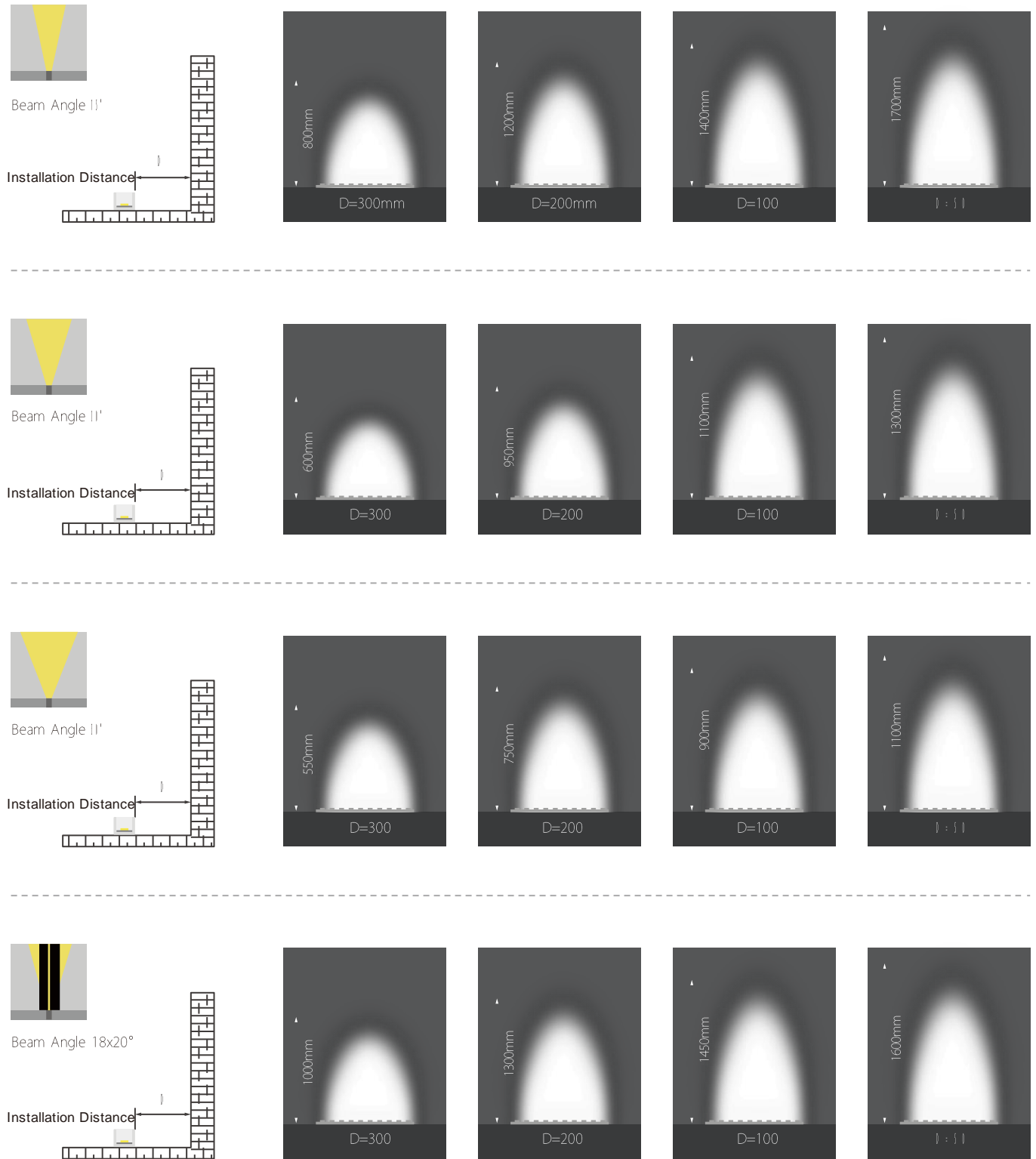



## Installation Distance/Wall Washing Height

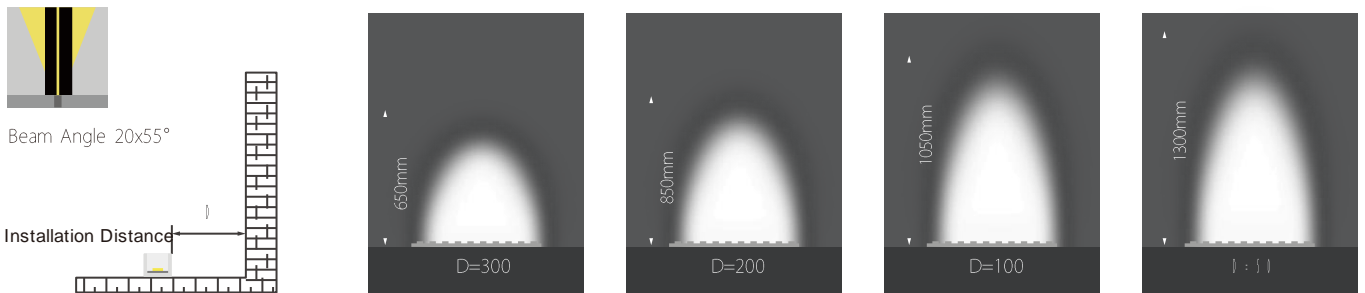
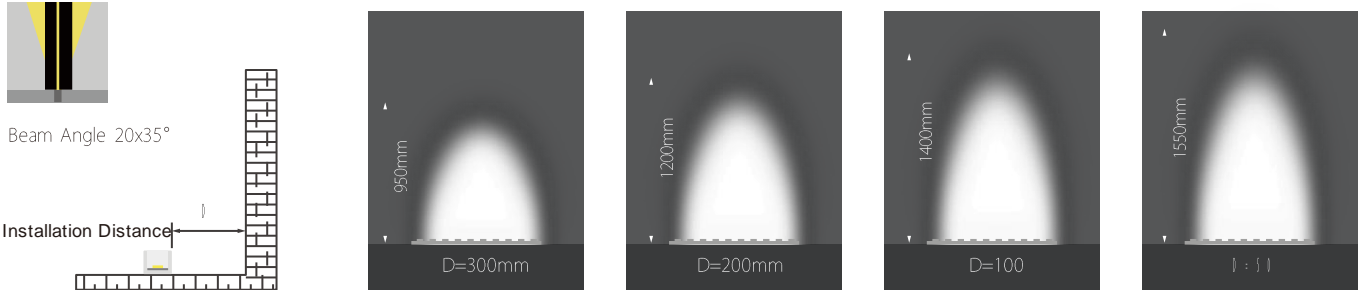

## Single Color Connection Diagram

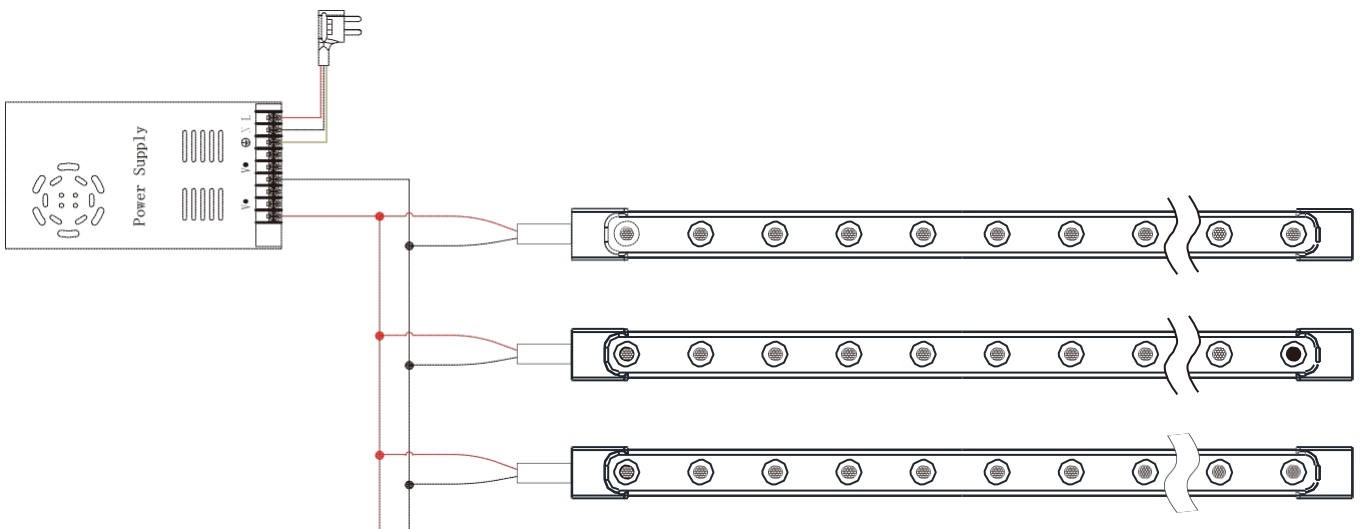

## Tunable white Connection Diagram

---

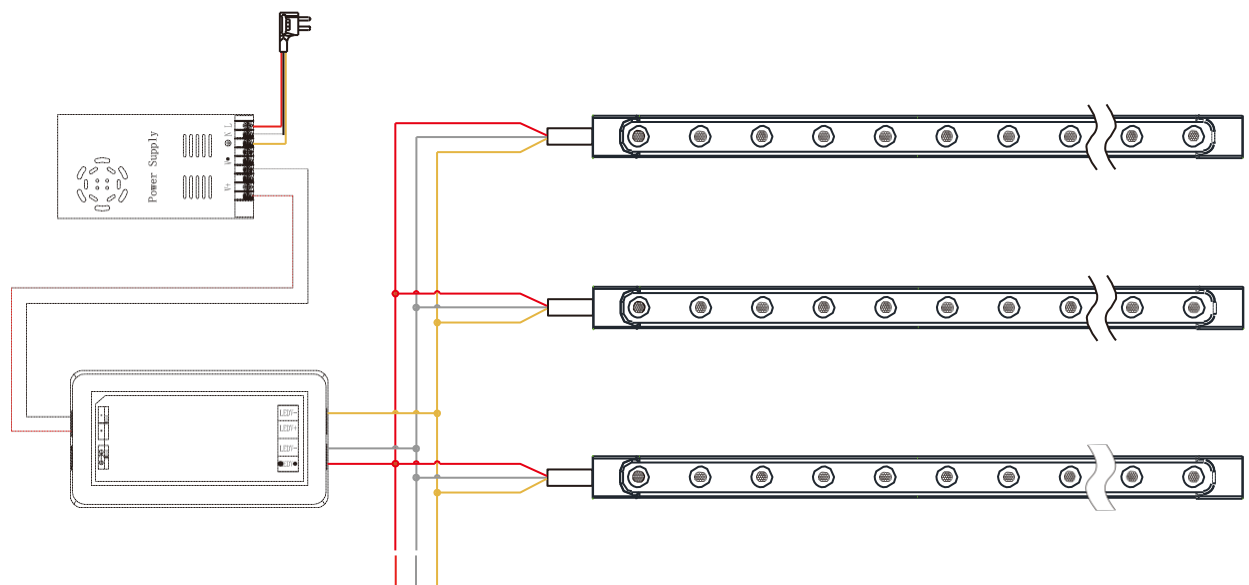

## RGB Connection Diagram

---

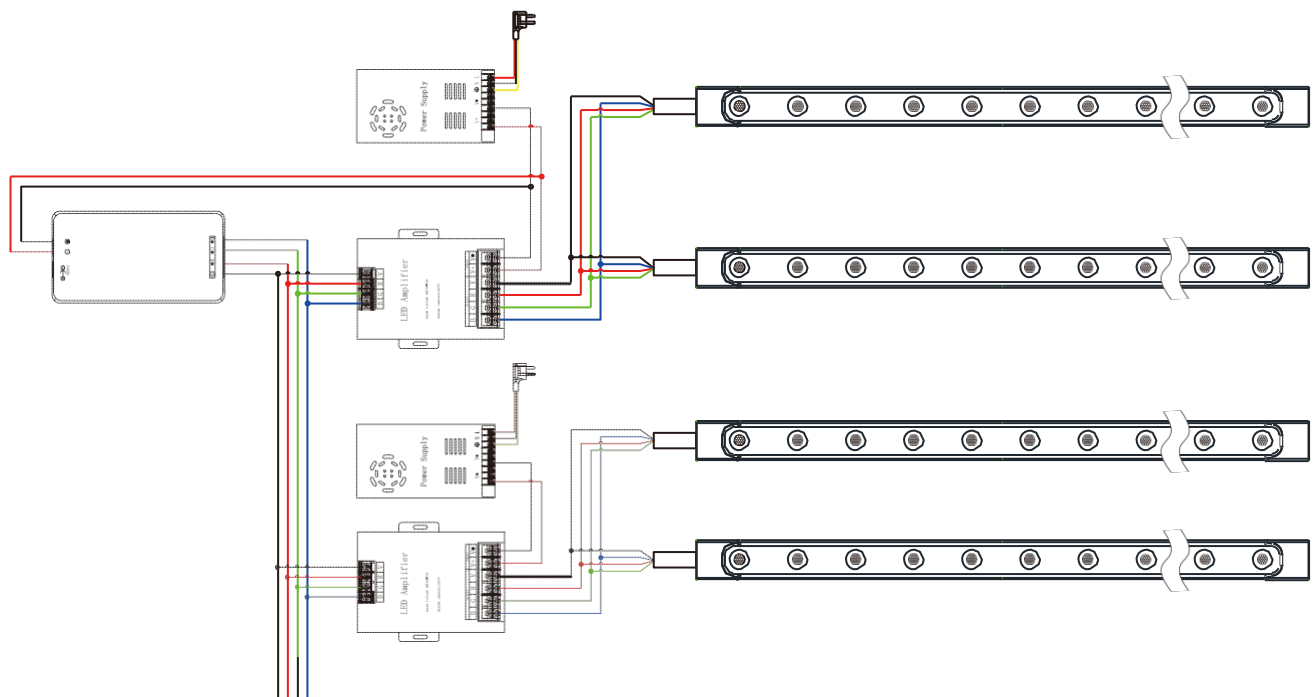

## RGBW Connection Diagram

---

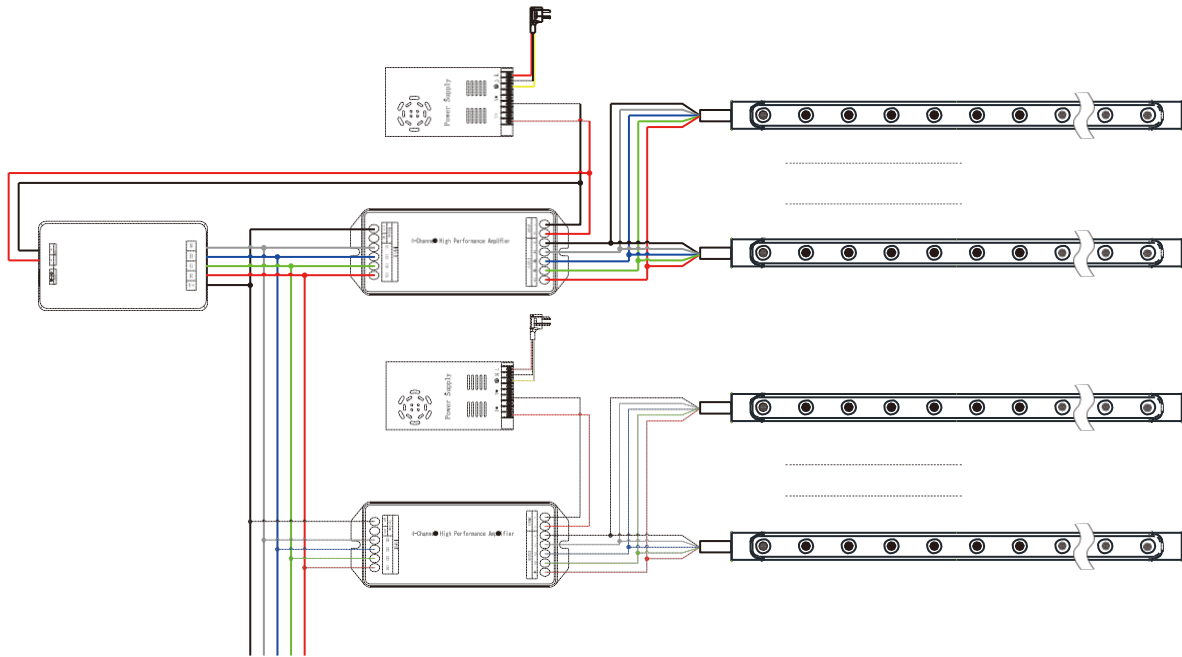

## DMX512 RGB Connection Diagram

---

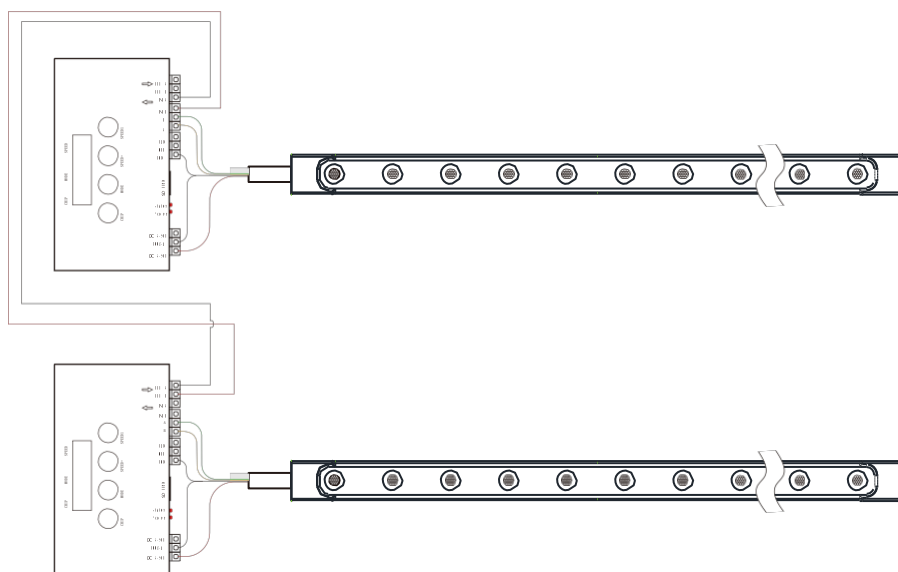

## Description of Product Model Code

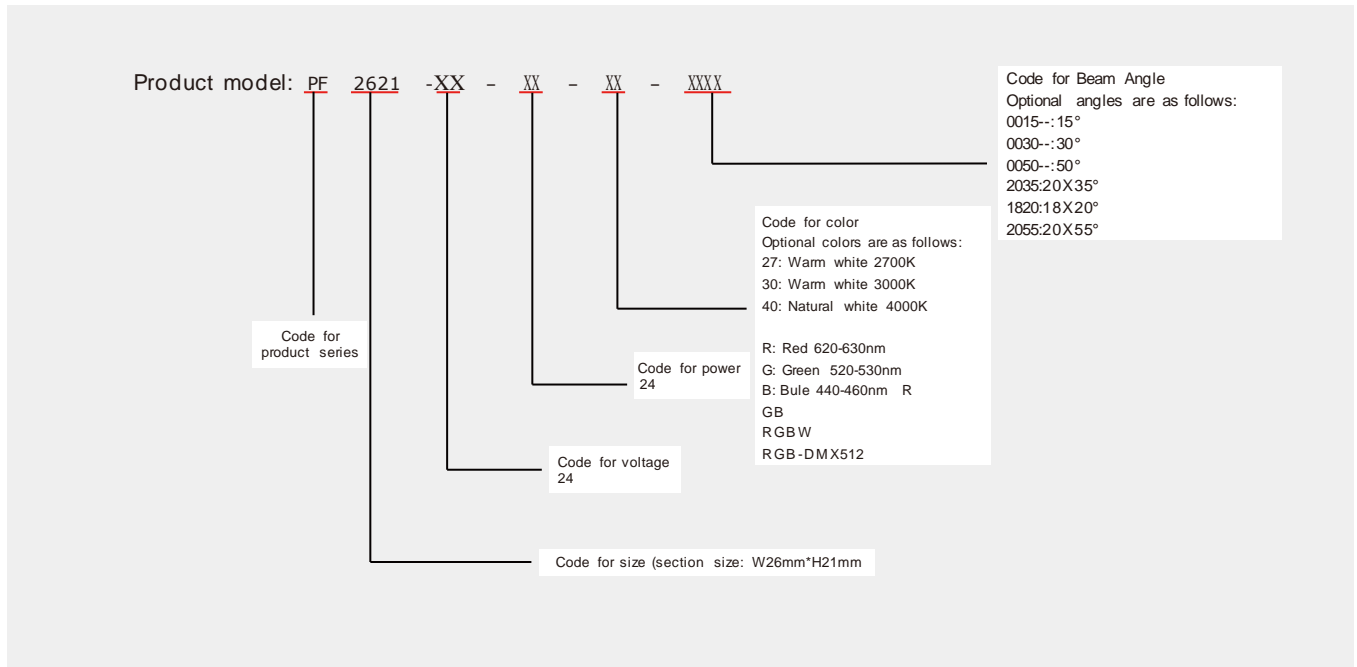

For example: The code of PF2621-24-24-65-2055

Wall section is 26x21mm

Voltage is DC24V

Power is 24W/M,

Colour Temperature is 6500K

Beam angle is 25x55°.